

SF-RAZ2G

TONGUE & GROOVE

2 Position hydraulic ring indexing chuck

- 3 self-centering and 3 compensating jaws
- Very compact design
- Fully automatic and controlled indexing
- Hydraulic actuation

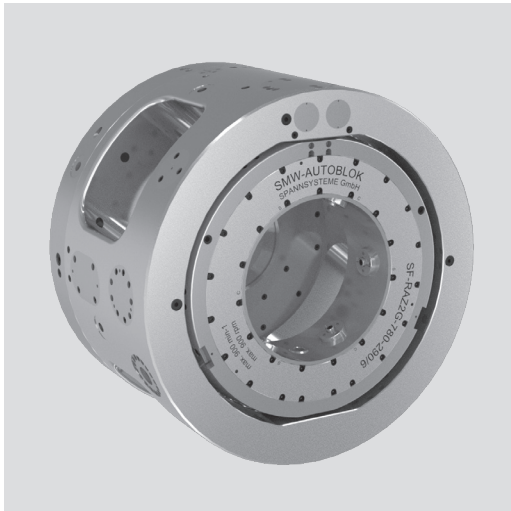

Application/customer benefits

- Machining of couplings in one set-up
- Indexing 180° in 2 seconds
- 6-jaw clamping for perfect roundness of the coupling = ideal for premium threads
- High-Low clamping (roughing - finishing)
- Central coolant supply available on request

Technical features

- Better chuck to workpiece dia. ratio
- Less chuck weight on the spindle
- Extremely accurate and rigid indexing mechanism with locking system free of clearance
- All functions controlled by proximity switches
- For external clamping only
- Automatic central lubrication

Standard equipment

Chuck with mounting bolts

Ordering example

SF-RAZ2G 710

Accessories

Hydraulic manifold including electric manifold, hose kit

Machining of a coupling in 1 set-up:

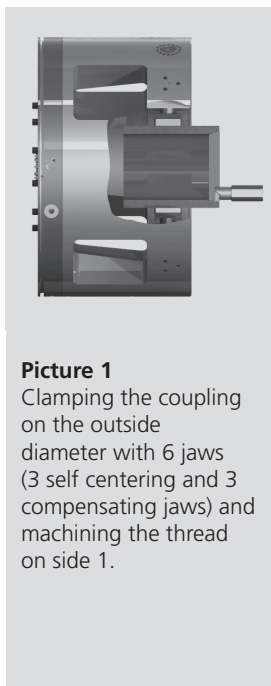

Picture 1

Clamping the coupling on the outside diameter with 6 jaws (3 self centering and 3 compensating jaws) and machining the thread on side 1.

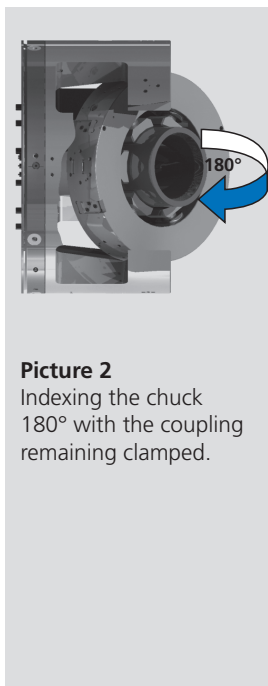

Picture 2

Indexing the chuck 180° with the coupling remaining clamped.

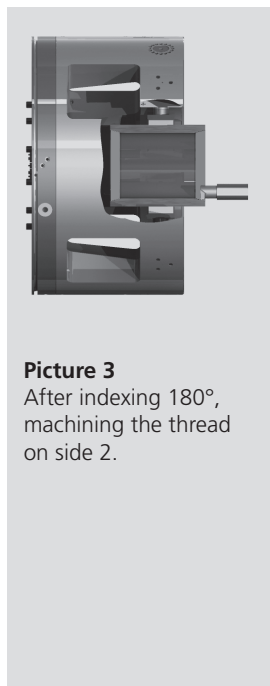

Picture 3

After indexing 180°, machining the thread on side 2.

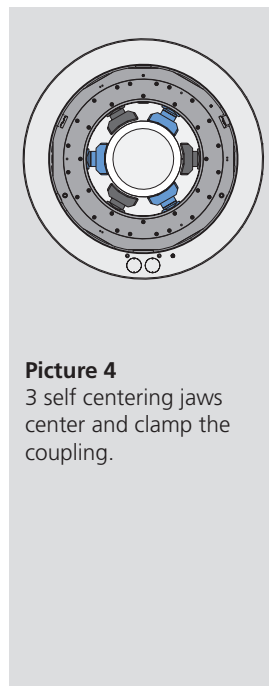

Picture 4

3 self centering jaws center and clamp the coupling.

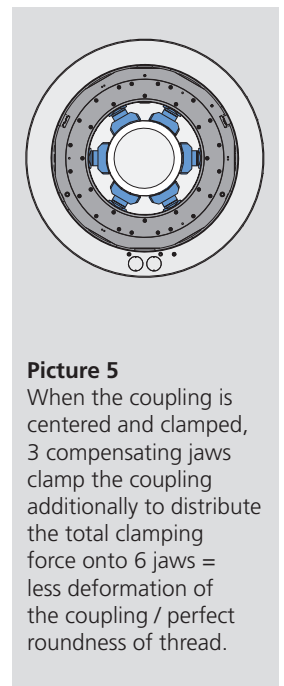

Picture 5

When the coupling is centered and clamped, 3 compensating jaws clamp the coupling additionally to distribute the total clamping force onto 6 jaws = less deformation of the coupling / perfect roundness of thread.

Technical data

SMW-AUTOBLOK Type		SF-RAZ2G 710-220	SF-RAZ2G 780-290	SF-RAZ2G 880-390	SF-RAZ2G 1100-570
Id. No.		054720	055170	054819	on request*
Number of jaws		3+3	3+3	3+3	3+3
Chuck O.D.	mm	710	780	880	1.100
Stroke per jaw	mm	10	10	10	10
Pressure max.	bar	70	70	70	70
Clamping force at 50 bar	kN	175	175	175	175
Clamping diameter max.	mm	220	290	390	570
Speed max.	r.p.m	1100	900	700	(*)
Weight	kg	800	~ 1.015	~ 1.380	~ 2.155
Coupling size / label size	inch	7 1/2"	9 5/8"	13 3/8"	20
Wall thickness (calc.)	mm	14.75	20	25	31

* Detailed dimensions on request.

■ Main dimensions and technical data

Data sheet shows no jaw dimensions and radial covers for switches and adjustments.
Data sheet shows only general dimensions!

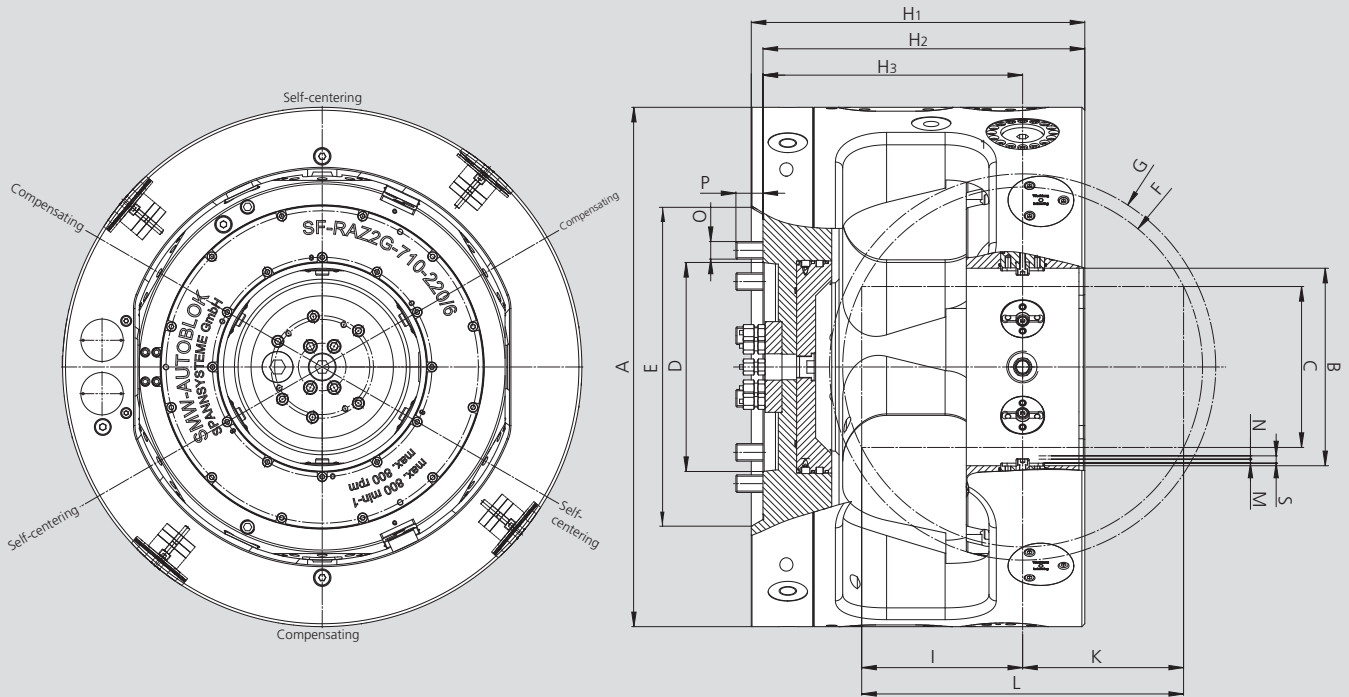

Subject to technical changes.
For more detailed information please ask our customer service.

SMW-AUTOBLOK Type			SF-RAZ2G 710-220	SF-RAZ2G 780-290	SF-RAZ2G 880-390	SF-RAZ2G 1100-570
Id. No.			054720	055170	054819	on request*
Chuck O.D.	A	mm	710	780	880	1100
Indexing ring I.D.	B	mm	270	340	440	
Max. workpiece O.D.	C	mm	220	290	390	570
Spindle mounting	D		A15	A15	A15	
Recess for spindle O.D.	E	mm	435	435	550	
Max. swing workpiece	F	mm	492	550	650	
Swing indexing ring	G	mm	528	598	698	
	H1	mm	456	491	555	
	H2	mm	440	475	539	
	H3	mm	355	390	454	
	I	mm	220	233.7	260	
	K	mm	220	233.7	260	
Max. length of workpiece	L	mm	440	467.4	520	
Rec. clamping stroke	M	mm	5.5	5.5	5.5	
Recom. residual stroke	N	mm	4.5	4.5	4.5	
Total jaw stroke	S	mm	10	10	10	
Mounting bolts	O	mm	M24	M24	M24	
	P	mm	37	37	37	

* Detailed dimensions on request.

Installation of SF-RAZ2G with hydraulic manifold, electric manifold and hose kit: (All accessories must be ordered separately)

